

Forme · Formes · Shapes · Formen · Formas



CHROME

AKURA 50



RX2 (V;INOX)

AKURA 50
AKURA 60

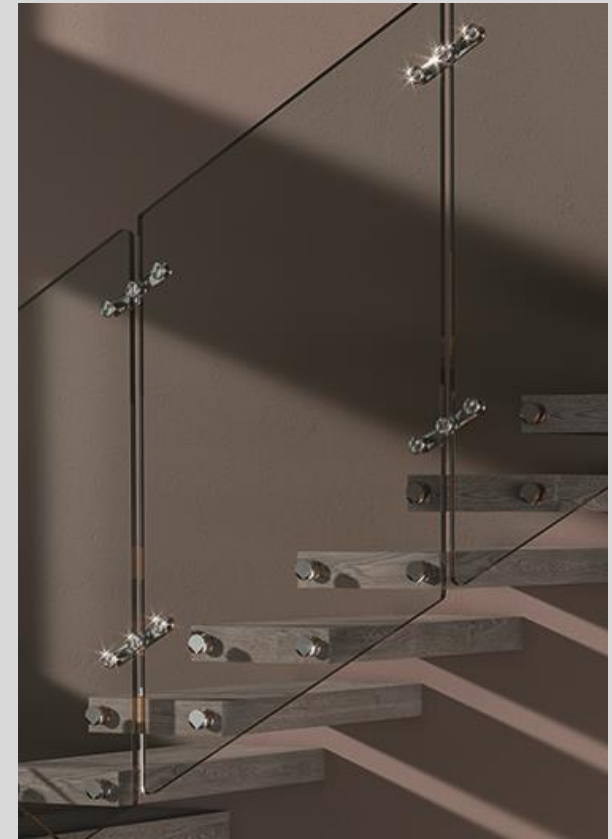

XR

AKURA 50
AKURA 60

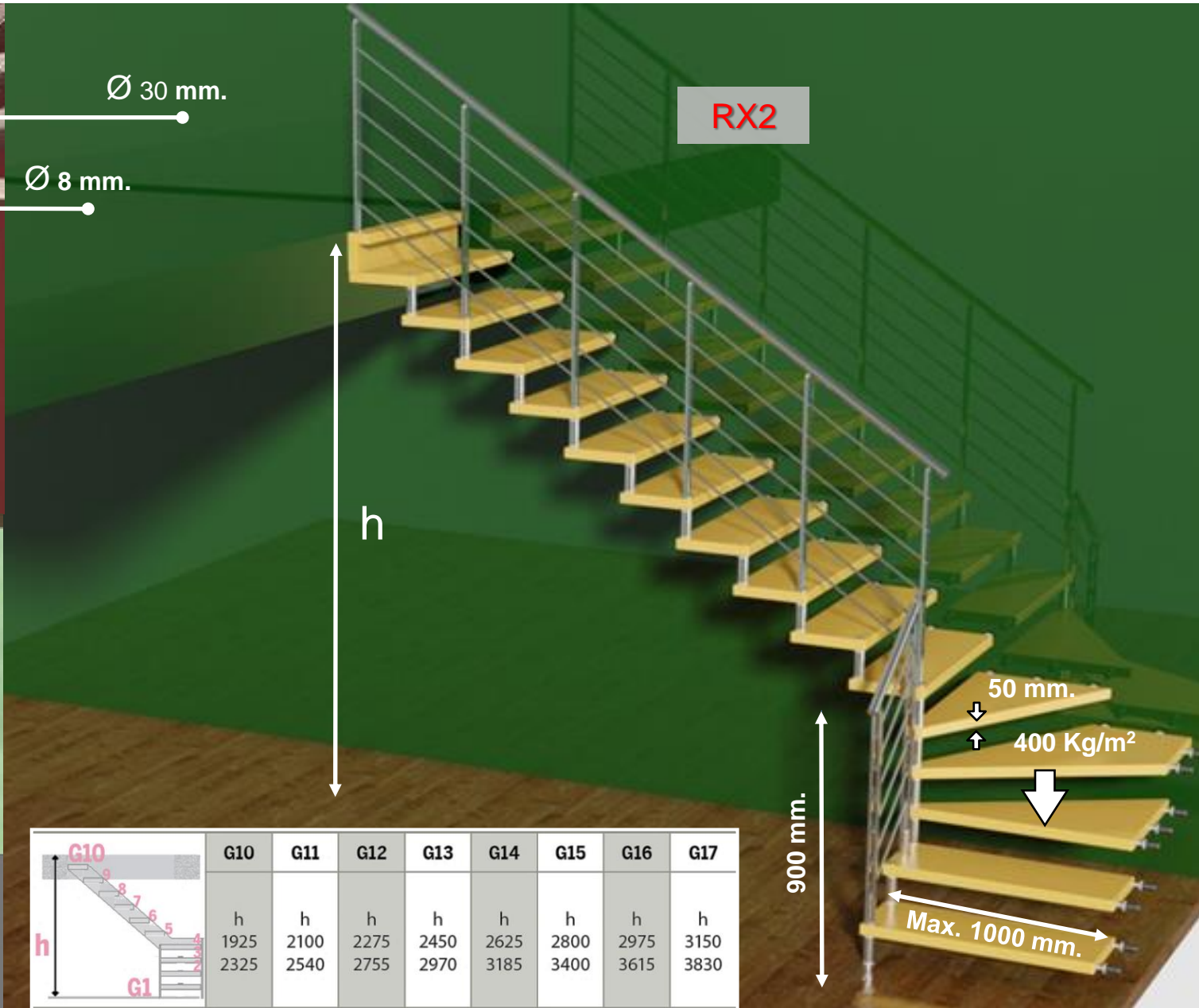
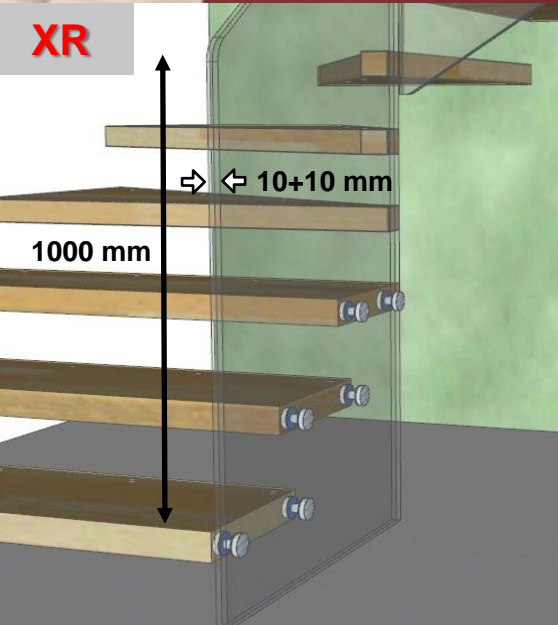
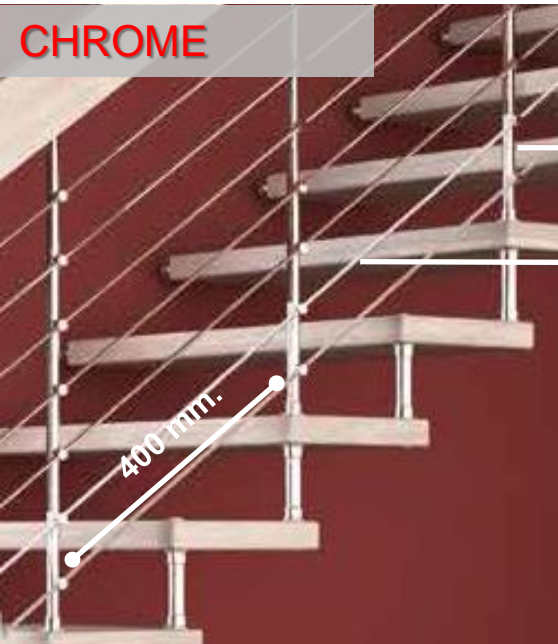

	G10	G11	G12	G13	G14	G15	G16	G17
h	h	h	h	h	h	h	h	h
	1925	2100	2275	2450	2625	2800	2975	3150
	2325	2540	2755	2970	3185	3400	3615	3830

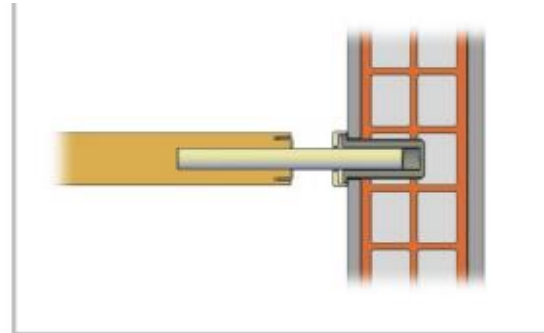
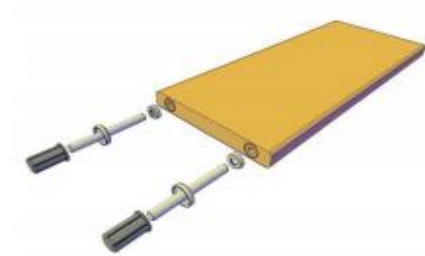

Tramezza
Partition wall
Cloison
Nicht Tragend Wand

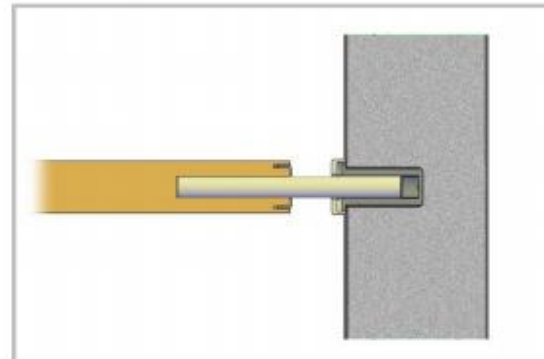

Portante
Bearing Wall
Mur portant
Hauptmauer

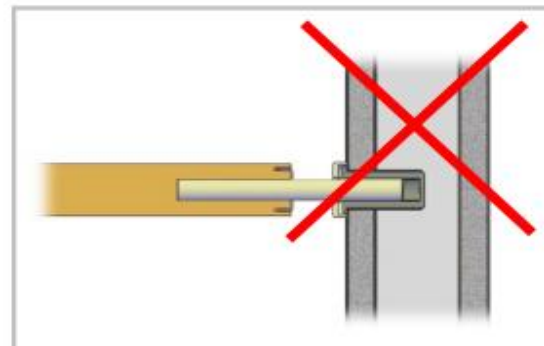

~~Cartongesso
Plaster board
Placoplâtre
Gipsplatte~~

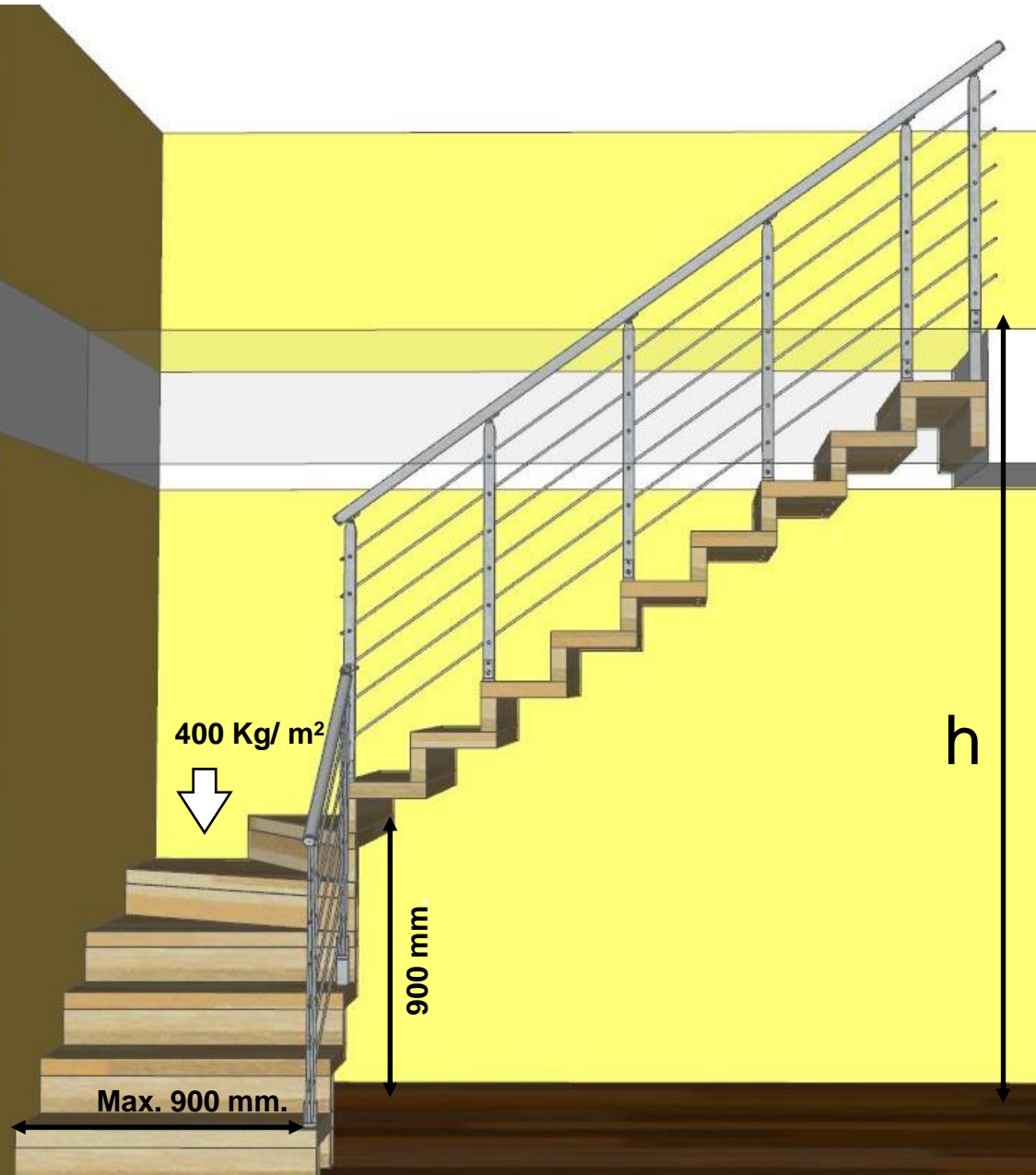

RX2

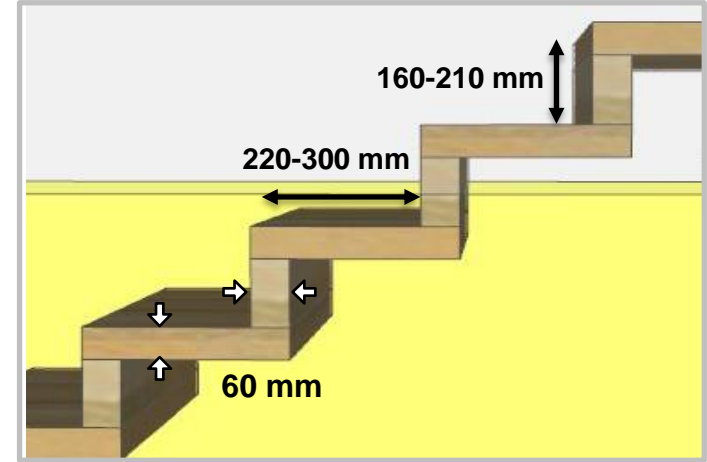
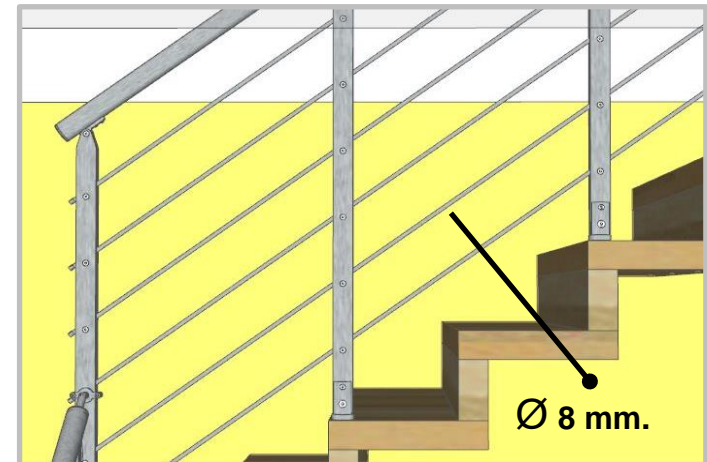

	G10	G11	G12	G13	G14	G15	G16	G17
h	h	h	h	h	h	h	h	h
	1925	2100	2275	2450	2625	2800	2975	3150
	2325	2540	2755	2970	3185	3400	3615	3830



XR

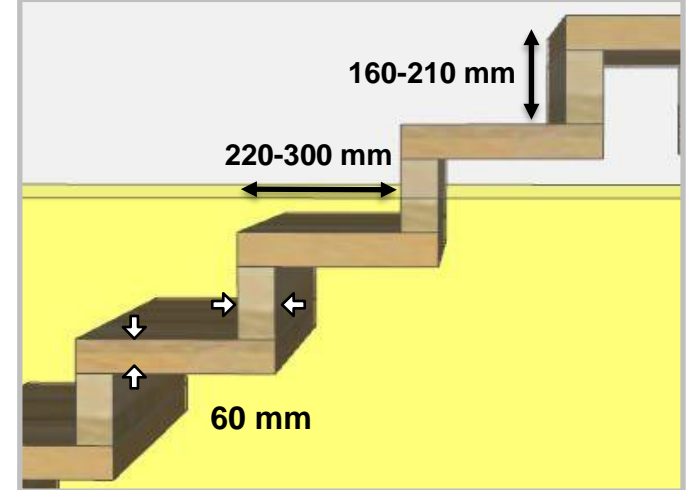
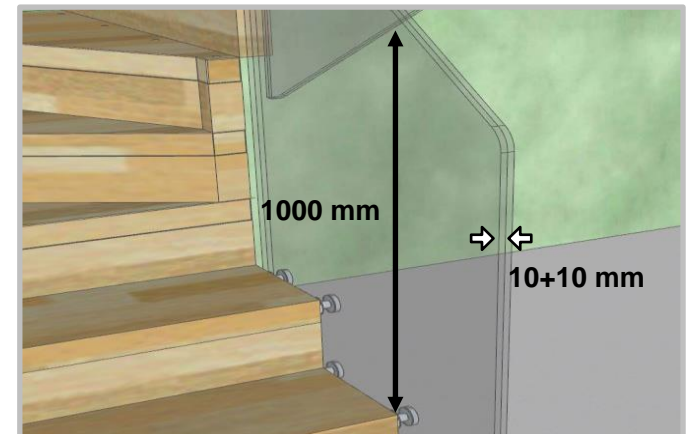
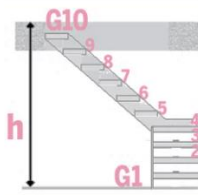

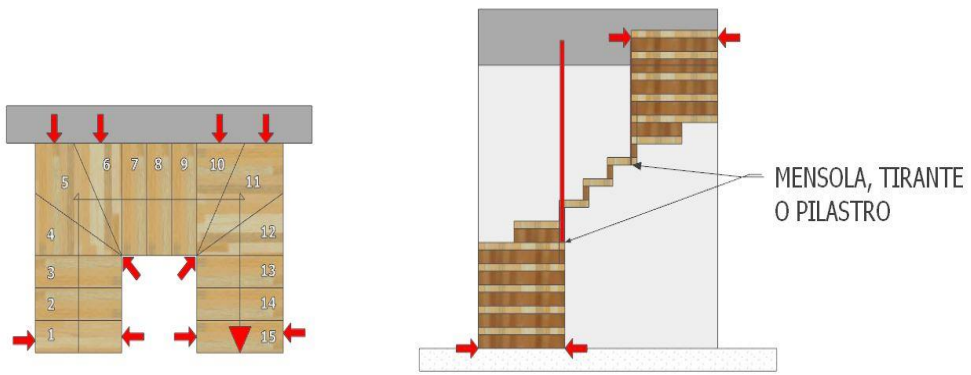
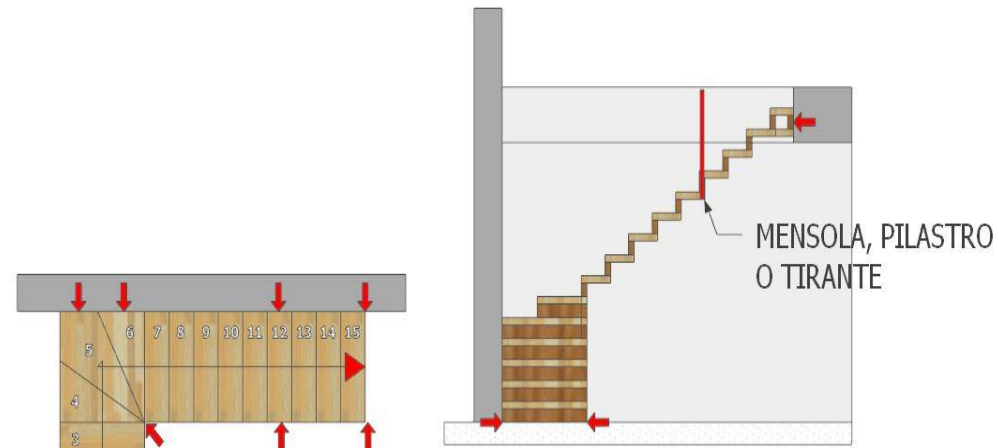
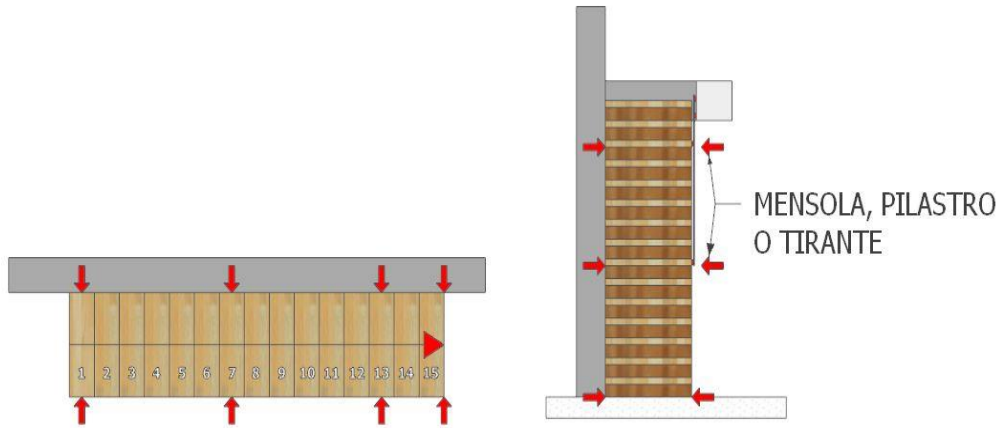

	G10	G11	G12	G13	G14	G15	G16	G17
h	h	h	h	h	h	h	h	h
	1925	2100	2275	2450	2625	2800	2975	3150
	2325	2540	2755	2970	3185	3400	3615	3830

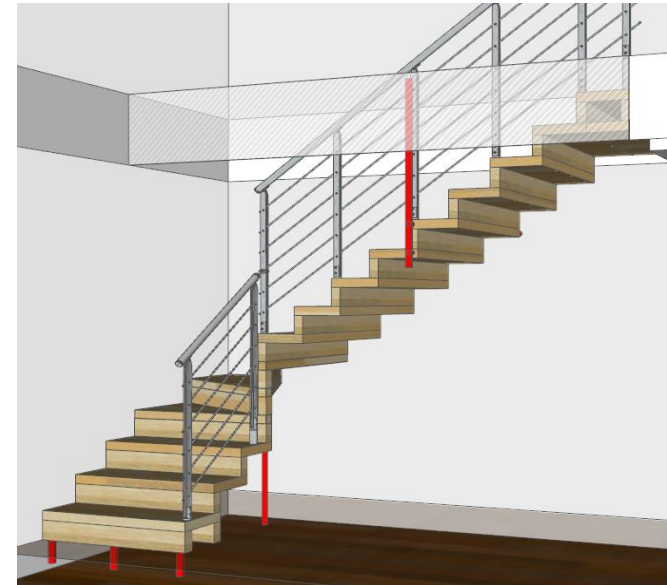
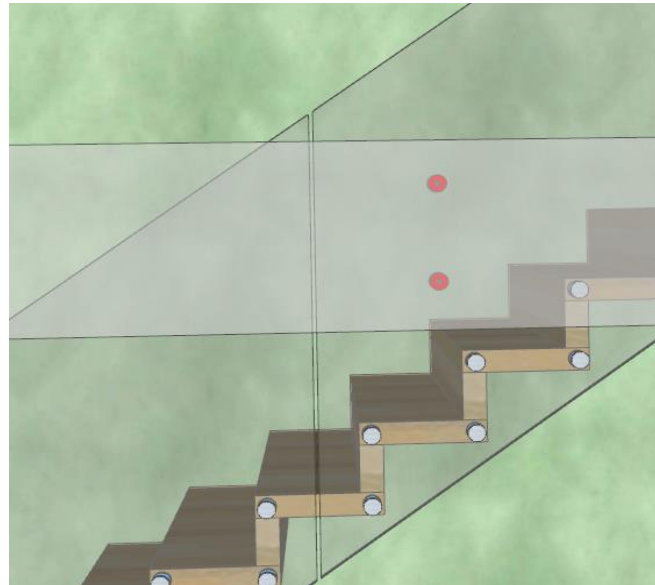
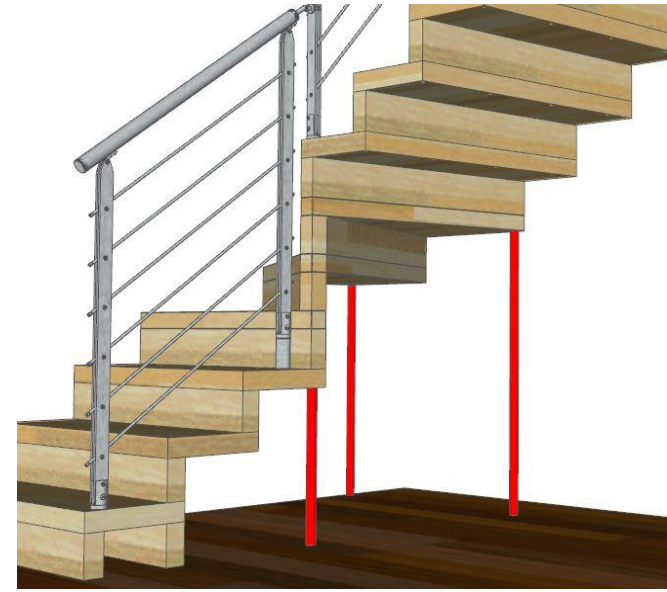
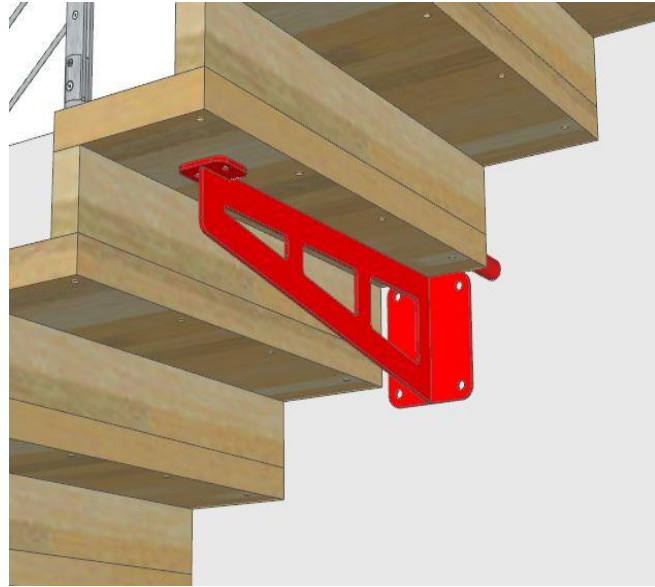

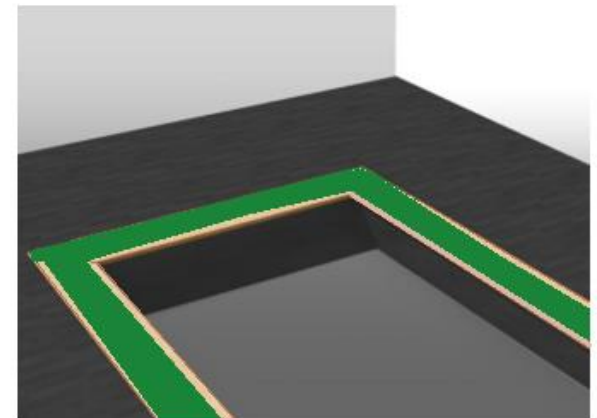
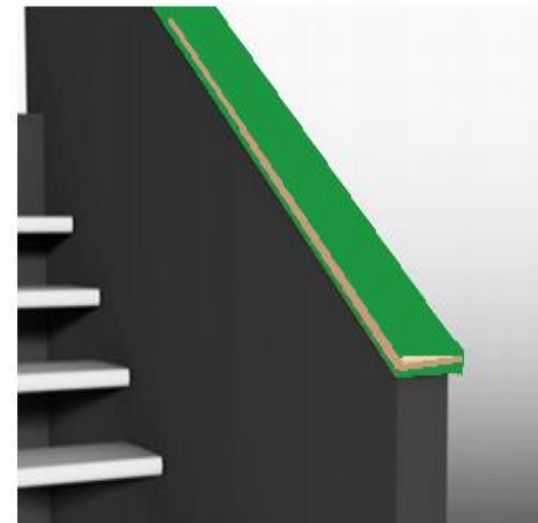
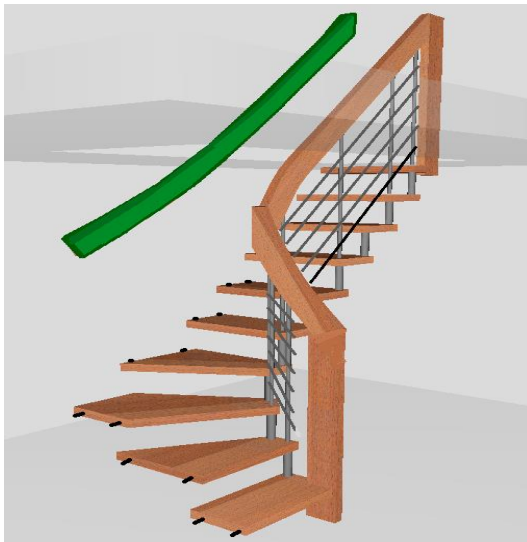
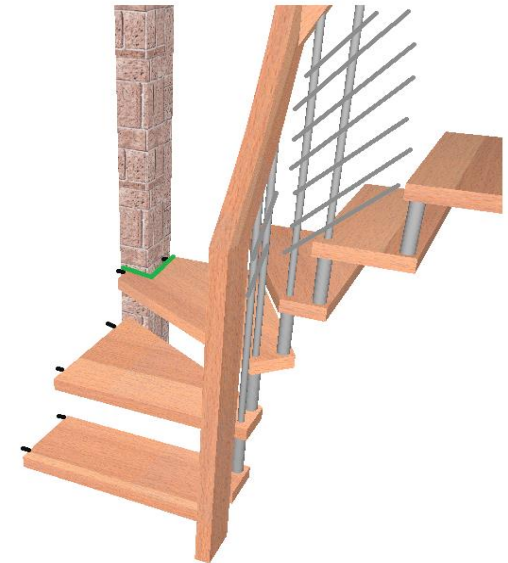
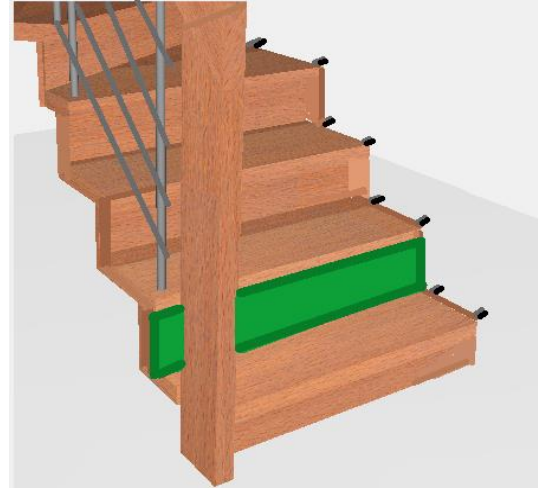

OPTIONAL



OPTIONAL

